

doi: 10.18720/MCE.72.7

## Mechanical properties of nanocarbon modified cement

## Механические свойства наноуглеродного цемента

*A.V. Cherkashin,  
K.A. Pykhtin,  
Y.E. Begich,  
P. A. Sherstobitova,  
T.S. Koltsova,  
Peter the Great St. Petersburg Polytechnic  
University, St. Petersburg, Russia*

*Аспирант, инженер А.В. Черкашин,  
студент К.А. Пыхтин,  
студент Я.Э. Бегич,  
студент П.А. Шерстобитова,  
канд. техн. наук, инженер Т.С. Кольцова,  
Санкт-Петербургский политехнический  
университет Петра Великого,  
г. Санкт-Петербург, Россия,*

**Key words:** buildings concrete; CNT; cement; civil engineering; construction materials; carbon nanotubes; nanofibers

**Ключевые слова:** бетонные здания; УНТ; цемент; гражданское строительство; строительные материалы; углеродные нанотрубки; нановолокна

**Abstract.** This article covers use of nanocarbon modified cement (nCMC) that was made with use of chemical vapor deposition method. The tests were performed with traditional destructive method as well as with the use of special ultrasonic equipment. The specimens with nCMC was tested for compressive and tensile strength. However, the results showed that use of nCMC made only minor effect on these characteristics, when results from other research groups indicate that nCMC improves cement's properties greatly. Therefore, authors hypothesize that characteristics of nCMC modified paste matrix highly dependent on the geometrical characteristics of nanofiber such as length, type of structure (single-walled, multi-walled) and chirality. This hypothesis is based on the ultrasonic tests' results. Furthermore, the positioning, distribution and the proportion in the material of carbon nanotubes (CNTs) needs to be researched more.

**Аннотация.** В статье рассмотрено использование наноуглеродного цемента (НУЦ), который был получен методом химического осаждения из газовой фазы. Испытания цементных материалов проводились традиционным разрушающим методом, а также с использованием специального ультразвукового оборудования. Образцы с НУЦ испытывали на прочность при сжатии и растяжении. Однако результаты показали, что использование НУЦ оказывает незначительное влияние на прочностные характеристики, в то время как результаты других исследовательских групп показывают, что НУЦ значительно улучшает свойства цемента. Поэтому авторы выдвигают гипотезу о том, что характеристики модифицированной пастообразной матрицы НУЦ сильно зависят от геометрических характеристик нановолокна, таких как длина, тип структуры (однослойные, многослойные) и хиральность. Кроме того, необходимы дополнительные исследования положения, распределения и доли в материале углеродных нанотрубок (УНТ).

### Introduction

Nanomaterials in construction industry became one of the most innovative line of research. Even though there are not many cases of their practical use, this field of search has many perspectives due to unique characteristics of these materials. Nanostructures allows to significantly improve such properties as: compressive strength, conductivity, and resistance to electromagnetic pulse (EMP) [1, 2]. Furthermore, use of nano-modified concrete can greatly reduce the cost of construction. This can be achieved by reducing the amount of cement in the compound of concrete.

Concrete being the most used material in construction is valued for its characteristics such as compressive strength, hardness and modulus of elasticity. However, nanotechnologies allowed to greatly improve these characteristics. A group of scientist from Saint Petersburg Polytechnical University (SPBPU) managed to greatly increase the compressive strength of concrete with synthesizing carbon nanofiber on cement particles [3]. The result of their research was hardened cement paste that was twice as strong as the control one. Moreover, civil engineers have been already using concrete with modifiers based on fullerene for a long time [4, 5]. These modifiers can also greatly improve compressive strength

Cherkashin A.V., Pykhtin K.A., Begich Y.E., Sherstobitova P.A., Koltsova T.S. Mechanical properties of nanocarbon modified cement. *Magazine of Civil Engineering*. 2017. No. 4. Pp. 54–61. doi: 10.18720/MCE.72.7.

of the concrete. However, the problem of equal distribution of modifier through the volume of the material still needs to be resolved for all types of nanomodifiers. So it can be concluded that there are two main trends in research of nano-concrete: synthesis of nanostructures on matrix material and direct addition of nanostructures into modified material [6–10].

Analysis of recent researches indicated the lack of data covering the test of cement hardened paste modified with nanocarbon modified cement (nCMC). Nevertheless, there is a lot of information about the concrete produced with use of special cavitalational setups [19], although this method of producing of concrete is quite complicated and there is no data considering simple mixing of nCMC with cement in certain proportions. Moreover, further analysis of this problem revealed that there is actually no information about attempts to define characteristics of nCMC that is simply mixed with standard cement in concrete mixture.

Therefore, the main goal of this research is to precisely examine the properties of nCMC. To achieve it our team had to produce the samples in lab conditions under the control of the supervisor, test them and analyze all gathered data.

### Experimental methods

To create specimens of modified cement was used special setup made on the base of Laboratory of lightweight materials and structures. The process of chemical vapor deposition allows to grow carbon nanostructures that may be formed into multi and single-walled structures. The possibility of formation of such structures is obtained due to the presence of iron in the clinker mineral celite. With increasing temperature and duration of the synthesis increases the amount of nanostructures, however the critical factor is the emergence of free CaO, which has negative impact on cement products. Regarding this, the temperature of synthesis is limited to 650 °C.

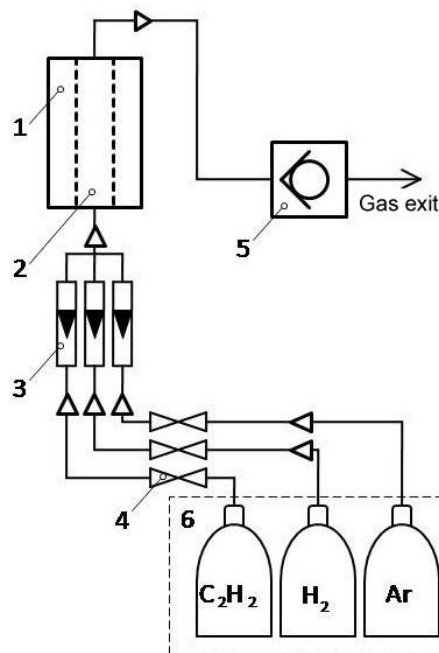

**Figure 1. Schematic diagram of the device used for nCMC synthesis:**

**1 – furnace, 2 – chemical reactor, 3 – rotameter, 4 – valves, 5 – hydraulic lock, 6 – gas tanks**

The cement used for this research has the following characteristic and compound: grade M500 D0, no additional mineral supplement,  $C_3S$  – 60.42 %,  $C_2S$  – 12.94 %,  $C_3A$  – 5.72 %,  $C_4AF$  – 12.46 %. Placed in a reactor with an argon atmosphere the cement of clinker minerals is heated to a temperature of 650 °C, the heating allows to recover hydrogen, and then argon got replaced by acetylene. As a result of catalytic decomposition of carbon in acetylene-hydrogen environment under atmospheric pressure, there can be noticed a growth of carbon nanotubes and nanofibers using carbon supersaturated iron catalyst. The catalyst particles can stay at the top of the nanofibers or nanotubes (apical growth) or in ground (root growth). The number of nanostructures depends on the amount of iron catalyst. In this case, 1 % by weight of the cement matrix

Tests of the specimens were performed in accordance with Russian State Standard GOST 310.4-81. "Cements. Methods for determination of flexural strength and compression".

To determine the water-cement ration of the mortar mix was used 1,500 g of standard uniform sand and 500 g of cement.

Sand and cement were mixed in a spherical cup, pre-rubbed with a wet cloth, and hand mixed for 1 minute. In the center of the dry mixture was made the deepening to which was added 200 g of water, in order to maintain water-cement ratio of 0.4. Water soaked for 30 seconds, and then the mixture was stirred again for 1 minute. After that mortar was put into Pan grinder (Fig. 2) for 150 seconds (20 rpm). After the additional mixing it was divided and put in the cone layer by layer. Then the form was mounted on a vibrating table. Each layer was also rodded 10–15 times. Then all the excesses were removed the mixture was shaken 30 times for 30 seconds. After all these procedures the form was removed and the lower base of the cone was measured in order to define the flow of this particular mixture.

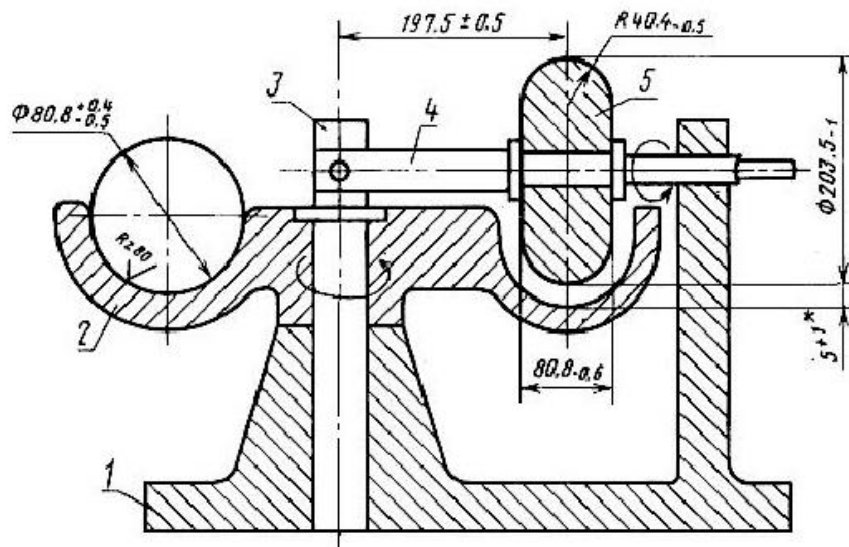

**Figure 2. Pan grinder:**  
**1 – base, 2- bowl, 3 – bowl axis, 4 – axis slider, 5 – runner**

With W/C = 0.40 the optimal flow of the mortar mix is considered to be around 106 ÷ 115 mm. If the flow is less than 106 mm, W/C should be increased in order to achieve the flow of 106 ÷ 108 mm. If the flow is more than 115 mm W/C need to be decreased to obtain the flow around 113 ÷ 115 mm. In our case the W/C = 0.48

For the production of control test specimen were used the following compound: 500g of cement (PC 500 D0), 1500g standard uniform sand and 240ml water (W/C = 0.48).

For the manufacturing of the beam specimens the mortar mix was prepared the same way as the mix for the definition of flow with the exception for the shaking part. The cement paste of standard consistency was laid in special forms with size 40 x 40 x 160 mm, that were attached to the vibrating table, and compacted by vibration for 3 minutes. Before switching on the vibration each section was filled with a 1 cm layer of a mortar mix. The remaining part of mixture was put during the first 120 seconds of vibration. After the vibrating, excesses of the mixture were removed and the surfaces were smoothed. Then specimens were put for 24 hours into chamber with high humidity level. Until the tests beams were stored in water under the temperature of 20+2C.

The test of the beams was performed at the age of 3, 7 and 28 days. The specimens were tested for their tensile and compressive strength using special presses.

Method of preparation of the control mortar mix was also used in the manufacture of test beams with nCMC in which certain amount of cement was replaced with nCMC respectively (1 %, 5 %, 10 %).

Furthermore, the specimens were tested with non-destructive method of ultra-sonic defect identification. All the specimens were tested with surface (Fig. 3a) and direct method (Fig. 3b). It should

be also mentioned that the surface method demanded three measurements of ultrasonic impulse velocity and each was determined from different side of the specimen.

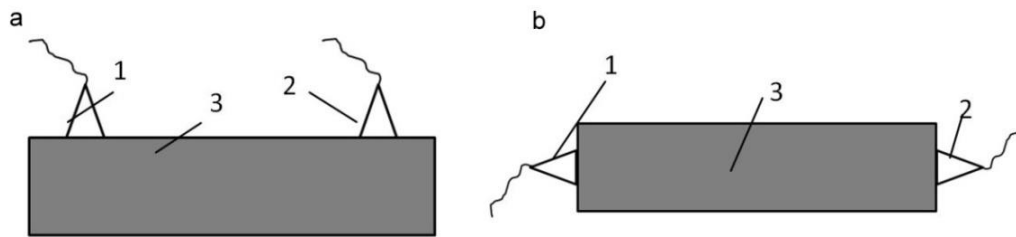

**Figure 3. Ultrasonic pulse velocity test: a – The surface (indirect) method, b –The direct method (cross probing). 1, 2 – transducer head, 3 – specimen**

### Experimental results

The data below states (Tab. 1) that noticeable improvement of the compressive strength (Fig. 4) was demonstrated only by the specimens that contained 1 % and 5 % of nCMC. Nevertheless, the control specimen turned out to have the maximum tensile strength (Fig. 5). It seems that these results are quite different in comparison to the group of researchers that managed more than 100 % of compressive strength improvement. [20–22]. But it may be only an indicator of the geometric characteristics of nanostructures. Only their presence is not a determining factor. Consider the length, thickness, density and mass of carbon nanostructures

**Table 1. Compressive and tensile strength of the specimens**

| № (%)            | Age, days                  |                                |                            |                                |                            |                                |
|------------------|----------------------------|--------------------------------|----------------------------|--------------------------------|----------------------------|--------------------------------|
|                  | 3                          |                                | 7                          |                                | 28                         |                                |
|                  | Tensile strength (Rt), MPa | Compressive strength (Rc), MPa | Tensile strength (Rt), MPa | Compressive strength (Rc), MPa | Tensile strength (Rt), MPa | Compressive strength (Rc), MPa |
| Control specimen | 7                          | 37.5                           | 8.2                        | 50.36                          | 8.6                        | 60.2                           |
| 1% nCMC          | 6.9                        | 37.5                           | 8.1                        | 51.85                          | 8.2                        | 61.8                           |
| 5% nCMC          | 6.6                        | 35.7                           | 7.8                        | 49.85                          | 8.2                        | 63.47                          |
| 10% nCMC         | 6.45                       | 33.14                          | 7.5                        | 48.65                          | 8.3                        | 58.82                          |

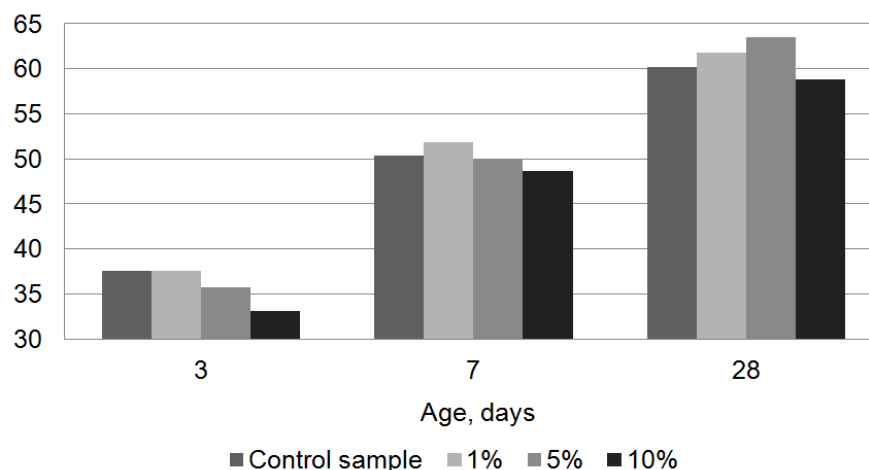

**Figure 4. Compressive strength of the specimens**

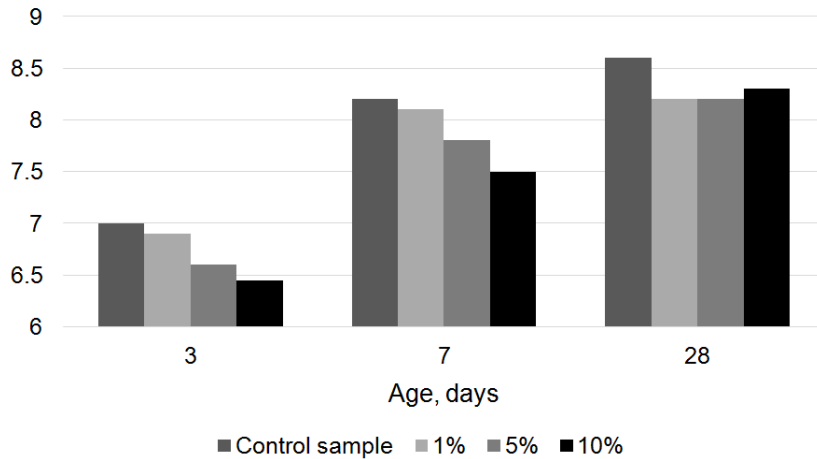

Figure 5. Tensile strength of the specimens

However, the ultrasonic tests discovered that velocity of the ultrasonic pulse highly varies between control and nCMC specimens (Fig. 6). The results showed that the speed of the impulse during the surface control of the compressive strength is about 16% higher in the modified specimens. Nevertheless, the direct method showed quite the similar numbers for all specimens. It should be also stated that during the compression tests the nCMC specimens was destroyed with a certain blast sound.

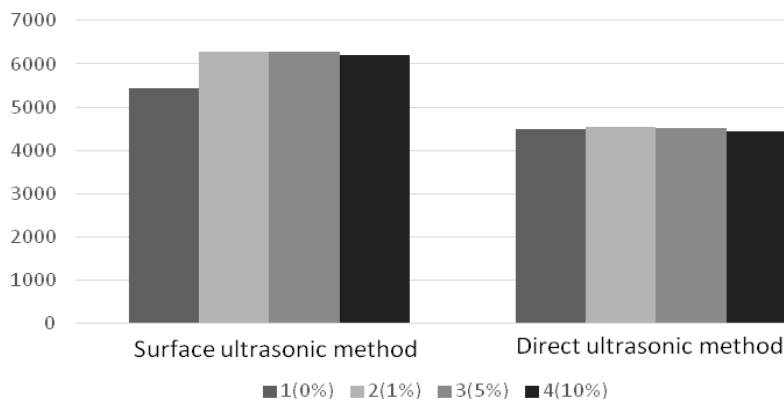

Figure 6. Results of ultrasonic impulse tests

The images below demonstrate two types of nCMC. The first one with lower density of CNTs (Fig.7a) represents the material that was tested within the scope of this article. The second one (Fig.7b) is the perspective material that is going to be tested in order to define the optimal geometric characteristics of CNTs synthesized on the cement matrix.

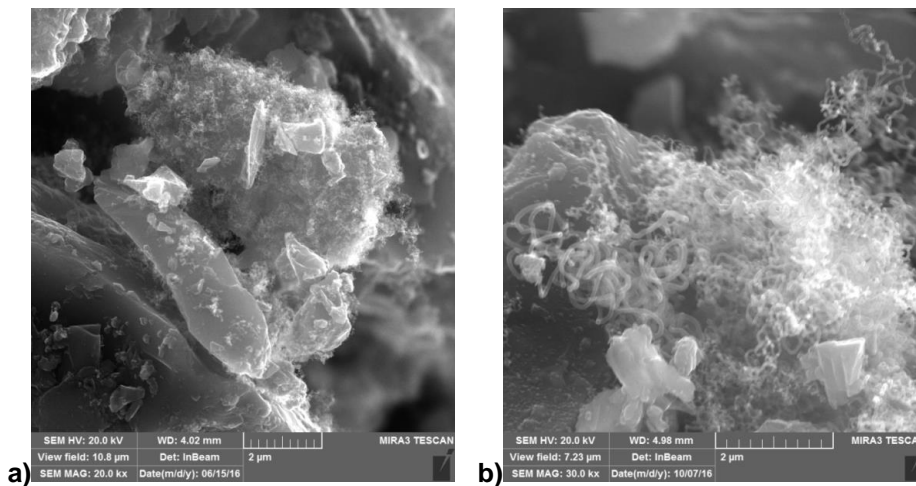

Figure 7. SEM images of the cement matrixes with different types of geometrical characteristics of CNTs. a – the content of the nanostructures 1 %, b – the content of the nanostructures 6 %

Cherkashin A.V., Pykhtin K.A., Begich Y.E., Sherstobitova P.A., Koltsova T.S. Mechanical properties of nanocarbon modified cement. *Magazine of Civil Engineering*. 2017. No. 4. Pp. 54–61. doi: 10.18720/MCE.72.7.



## Discussion

The effectiveness of nCMC synthesized under different conditions can be only determined experimentally, however photos of the specimens allow us to suppose that compressive strength correlates with geometrical configuration of nanofibers on the cement. It seems that the synthesis of longer carbon nanotubes with higher density may lead to greater improvement of strength that just may be a confirmation of the study [23–25], where presented the research of foamed concrete, where they tested carbon nanomaterial that was a mixture of nanotubes and nanofibers with an average diameter of 20–40 nm and 2  $\mu$ m long.

The figure shows (Fig.8) the approximate area of maximum hydration, which produces maximum internal stress

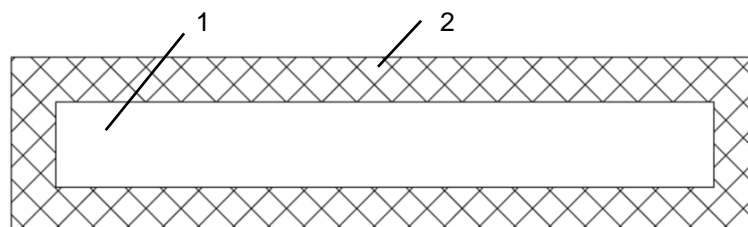

**Figure 8. Approximate spreading of CNFs throughout the specimens:  
1 – area presumably less hydration, 2 – area presumably the maximum hydration**

Therefore it may be concluded that proper geometrical characteristics of nanofibers still have to be defined.

Furthermore, on the images in results section it is clearly seen that the length and density of nanofibers on the new specimens have multiplied and with following researches we will be able to compare different geometrical characteristics of CNTs.

## Conclusions

However, as it was stated before, final conclusion can only be made after proper experiments. Nevertheless, on this stage of research we can already made following conclusions:

- Geometrical characteristics of nanofiber can greatly improve mechanical features of the concrete. Therefore, the main goal is to determine the most effective set. It is very perspective field of study because the majority of researches only defined the optimal concentration of nCMC or tested only concentration of the CNTs.
- During lab tests was noticed the fact that all nCMC-containing specimens had better results only in surface ultrasonic tests. With such dispersion of the CNTs throughout the specimens we can made a hypothesis that cement in the middle of the specimens had no feasibility to be properly hydrated. This can be explained by hydrophilicity of carbon, which prevented the penetration of water in the middle part of the sample. Nevertheless, it could be also stated that the porosity of the material in the outer layers lowered. This can lead to better water and frost resistance characteristics.

## References

1. Lihtorovich S.P., Nishchenko M.M., Galstyan I.E. Vliyanie nanotrubok na parametry nanopor i radiopogloshenie nachastote 2 GGc vo ftoroplaste F4 [Influence of nanotubes on the parameters of the nanopore and radiopogloshenie at 2 GHz I n the fluoropolymer F4]. *Metal Physics and the Latest Technology*. 2010. Vol. 32. No. 4. Pp. 475–486. (rus)
2. Ushakov N.M., Molchanov S.Y. Radiopogloshayushhie svojstva matrichnyh polimernyh kompozitnyh nanomaterialov v svch-diapazone radiovoln [Radio-absorbing properties of the matrix polymer composite nanomaterials in microwave radio waves]. *Nanotechnology: Development, application-XXI CENTURY*. 2015. Vol. 7. No. 4. Pp. 25–30. (rus)
3. Nasibulin A.G. A novel aerosol method for single walled carbon nanotube synthesis. *Chemical Physics Letters*.

## Литература

1. Лихторович С.П., Нищенко М.М., Галстян И.Е. Влияние нанотрубок на параметры nanopor и радиопоглощение на частоте 2ГГц во фторопласте Ф4 // *Металлофизика и новейшие технологии*. 2010. № 4. С. 475–486.
2. Ушаков Н.М., Молчанов С.Ю. Радиопоглощающие свойства матричных полимерных композитных наноматериалов в СВЧ-диапазоне радиоволн. *Нанотехнологии: разработка, применение – XXI век*. 2015. № 4. С. 25–30.
3. Nasibulin A. G. A novel aerosol method for single walled carbon nanotube synthesis // *Chemical Physics Letters*. 2005. Vol. 402. Pp. 227–232.
4. Елецкий А.В., Смирнов Б.М. Фуллерены и структуры углерода // *Успехи физических наук*. 1995. Т. 165. № 9. С. 977–1009.
5. Ширинкина С. Фуллерены. История открытия и

Черкашин А.В., Пыхтин К.А., Бегич Я.Э., Шерстобитова П.А., Кольцова Т.С. Механические свойства нанотрубочного цемента // *Инженерно-строительный журнал*. 2017. № 4(72). С. 54–61.

2005. Vol. 402. Pp. 227–232.
4. Eletsii A.V., Smirnov B.M. Fullereny i struktury ugleroda [Fullerenes and carbon structures]. *Physics-Uspekhi (Advances in Physical Sciences)*. 1995. Vol. 165. No. 9. Pp. 977–1009. (rus)
  5. Shirinkina S. Fullereny. Istoriyaotkrytiya i ispol'zovaniya [Fuller. history opening and use of energy]. *Business, Technology, Environment*. 2013. No. 10. Pp. 63–66. (rus)
  6. Jo B.W., Choi J.S., Kang S.W. An experimental study on the characteristics of chemically synthesized nano-cement for carbon dioxide reduction. *Advanced Materials Research. Trans Tech Publications*. 2011. Vol. 148. Pp. 1717–1721.
  7. Al-Rifaie W.N., Mahdi O.M., Ahmed W.O.K. Development of nanocement mortar as a construction material. *Advanced Materials Research. Trans Tech Publications*. 2013. Vol. 795. Pp. 684–691.
  8. Jo B.W. et al. Effectiveness of the top-down nanotechnology in the production of ultrafine cement. *Journal of Nanomaterials*. 2014. P. 57.
  9. Sobolev K. et al. Engineering of SiO<sub>2</sub> nanoparticles for optimal performance in nano cement-based materials. *Nanotechnology in Construction*. 2009. No. 3. Pp. 139–148.
  10. Dham M. et al. Enhancement of reactive powder concrete via nanocementintegration. *Transportation Research Record: Journal of the Transportation Research Board*. 2010. No. 2142. Pp. 18–24.
  11. Srinivas K. Nanomaterials for concrete technology. *International Journal of Civil, Structural, Environmental and Infrastructure Engineering Research and Development (IJCSIEIRD)*. 2014. Vol. 1. No. 4. Pp. 79–90.
  12. Sobolev K. Nanomaterials and nanotechnology for high-performance cement composites. *Proceedings of ACI Session on Nanotechnology of Concrete: Recent Developments and Future Perspectives*. 2006. Pp. 91–118.
  13. Mendes T.M., Hotza D., Repette W.L. Nanoparticles. *Cement Based Materials: A Review. Rev. Adv. Mater. Sci*. 2015. Vol. 40. Pp. 89–96.
  14. Ghosal M., Chakraborty A.K. A comparative study of nano embedments on different types of cements. *International Journal of Advances in Engineering & Technology*. 2015. Vol. 8. No. 2. P. 92.
  15. Sanchez F., Sobolev K. Nanotechnology in concrete—a review. *Construction and Building Materials*. 2010. Vol. 24. No. 11. Pp. 2060–2071.
  16. Chen X.W. Direct synthesis of carbon nanofibers on modified biomass-derived activated carbon. *Carbon*. 2009. Vol. 47. No. 1. Pp. 340–343.
  17. Li G.Y. Mechanical behavior and microstructure of cement composites incorporating surface-treated multi-walled carbon nanotubes. *Carbon*. 2005. Vol. 43. Pp. 1239–1245.
  18. Musso S. Influence of carbon nanotubes structure on the mechanical behavior of cement composites. *Composites Science and Technology*. 2009. Vol. 69. Pp. 1985–1990.
  19. Gusev B.V., Petrunina S.Y. Kavitationnoe dispergирование uglerodnyh nanotrubok i modifizirovanie cementnyh sistem [Cavitation dispersion of carbon nanotubes and modifying cement systems]. *Nanotechnology in Construction*. 2014. Vol. 6.No. 6. Pp. 50–57. (rus)
  20. Iijima S. Helical microtubules of graphitic carbon. *Nature*. 1991. Vol. 354. No. 6348. Pp. 56–58.
  21. Diachkov P.N. *Uglерodnye Nanotrubki: Stroenie, Svoystva, Primeneniya* [Carbon nanotubes: structure, properties and application] Moscow: Bean. Knowledge Lab. 2006. 293 p. (rus)
  22. Nasibulina L.I. Carbon nanofiber/clincer hybrid material as a highly efficient modifier of mortar mechanical properties. *Materials Physics and Mechanics*. 2012. Vol. 13. Pp. 63–66.
  23. Ткачев А.Г., Михалев З.А., Ладохин М.Н., Жутово Е.А. Модифицирование строительных композитов углеродными наноматериалами // Международный научный журнал Альтернативная энергетика и экология. 2007. № 9. С. 56–59.
  24. Smilauer, V. Micromechanical analysis of cement paste использования. Бизнес, технология, среда. 2013. № 10. С. 63–66.
  6. Jo B.W., Choi J.S., Kang S.W. An experimental study on the characteristics of chemically synthesized nano-cement for carbon dioxide reduction // Advanced Materials Research. Trans Tech Publications. 2011. Vol. 148. Pp. 1717–1721.
  7. Al-Rifaie W.N., Mahdi O.M., Ahmed W.K. Development of nanocement mortar as a construction material // Advanced Materials Research. Trans Tech Publications. 2013. Vol. 795. Pp. 684–691.
  8. Jo B.W. et al. Effectiveness of the top-down nanotechnology in the production of ultrafine cement // Journal of Nanomaterials. 2014. Vol. 2014. P. 57.
  9. Sobolev K. Engineering of SiO<sub>2</sub> nanoparticles for optimal performance in nano cement-based materials // Nanotechnology in Construction. 2009. № 3. Pp. 139–148.
  10. Dham M. et al. Enhancement of reactive powder concrete via nanocementintegration // Transportation Research Record: Journal of the Transportation Research Board. 2010. № 2142. Pp. 18–24.
  11. Srinivas K. Nanomaterials for concrete technology // International Journal of Civil, Structural, Environmental and Infrastructure Engineering Research and Development (IJCSIEIRD). 2014. Vol. 1. № 4. Pp. 79–90.
  12. Sobolev K. Nanomaterials and nanotechnology for high-performance cement composites // Proceedings of ACI Session on Nanotechnology of Concrete: Recent Developments and Future Perspectives. 2006. Pp. 91–118.
  13. Mendes T. M., Hotza D., Repette W. L. Nanoparticles // Cement Based Materials: A Review. Rev. Adv. Mater. Sci. 2015. Vol. 40. Pp. 89–96.
  14. Ghosal M., Chakraborty A.K. A Comparative study of nano embedments on different types of cements // International Journal of Advances in Engineering & Technology. 2015. Vol. 8. № 2. P. 92.
  15. Sanchez F., Sobolev K. Nanotechnology in concrete—a review. Construction and Building Materials. 2010. Vol. 24. No. 11. Pp. 2060–2071.
  16. Chen X. W. Direct synthesis of carbon nanofibers on modified biomass-derived activated carbon // Carbon. 2009. Vol. 47. № 1. Pp. 340–343.
  17. Li G. Y. Mechanical behavior and microstructure of cement composites incorporating surface-treated multi-walled carbon nanotubes // Carbon. 2005. Vol. 43. Pp. 1239–1245.
  18. Musso S. Influence of carbon nanotubes structure on the mechanical behavior of cement composites // Composites Science and Technology. 2009. Vol. 69. Pp. 1985–1990.
  19. Гусев Б.В., Петрушин С.Ю. Кавитационное диспергирование углеродных нанотрубок и модифицирование цементных систем // Нанотехнологии в строительстве. 2014. Т. 6. № 6. С. 50–57.
  20. Iijima S. Helical microtubules of graphitic carbon // Nature. 1991. Vol. 354. № 6348. Pp. 56–58.
  21. Дьячков П.Н. Углеродные нанотрубки: строение, свойства, применения. М.: БИНОМ. Лаборатория знаний. 2006. 293 с.
  22. Nasibulina L. I. Carbon nanofiber/clincer hybrid material as a highly efficient modifier of mortar mechanical properties // Materials Physics and Mechanics. 2012. Vol. 13. Pp. 77–84.
  23. Ткачев А.Г., Михалев З.А., Ладохин М.Н., Жутово Е.А. Модифицирование строительных композитов углеродными наноматериалами // Международный научный журнал Альтернативная энергетика и экология. 2007. № 9. С. 56–59.
  24. Smilauer, V. Micromechanical analysis of cement paste

Cherkashin A.V., Pykhtin K.A., Begich Y.E., Sherstobitova P.A., Koltsova T.S. Mechanical properties of nanocarbon modified cement. *Magazine of Civil Engineering*. 2017. No. 4. Pp. 54–61. doi: 10.18720/MCE.72.7.

- Pp. 77–84.
23. Tkachev A.G., Mikhalev Z.A., Ladokhin M.N., Zhutova E.A. Modificirovanie stroitel'nyh kompozitov uglerodnymi nanomaterialami [Modifying the construction of composites with carbon nanomaterials]. *International Scientific Journal for Alternative Energy and Ecology*. 2007. No. 9. Pp. 56–59. (rus)
  24. Smilauer, V. Micromechanical Analysis of Cement Paste with Carbon Nanotubes. *ActaPolytechnica*. 2012. Vol. 52. Pp. 22–28.
  25. Sobolkina A., Mechtcherine V., Khavrus V., Maier D., Mende M., Ritschel M., Leonhardt A. Dispersion of carbon nanotubes and its influence on the mechanical properties of the cement matrix. *Cement and Concrete Composites*. 2012. Vol. 34. Pp. 1104–1113.
  26. Konsta-Gdoutos M.S., Metaxa Z.S., Shah S.P. Highly dispersed carbon nanotube reinforced cement based materials. *Cement and Concrete Research*. 2010. Vol. 40. Pp. 1052–1059.
  27. Konsta-Gdoutos M.S., Metaxa Z.S., Shah S.P. Multi-scale mechanical and fracture characteristics and early-age strain capacity of high performance carbon nanotube/cement nanocomposites. *Cement and Concrete Composites*. 2010. Vol. 32. Pp. 110–115.
  28. Manzur T., Yazdani N. Optimum mix ratio for carbon nanotubes in cement mortar. *KSCE Journal of Civil Engineering*. 2015. Vol. 19. No. 5. Pp. 1405–1412.
  - with carbon nanotubes // *ActaPolytechnica*. 2012. Vol. 52. Pp. 22–28.
  25. Sobolkina A., Mechtcherine V., Khavrus V., Maier D., Mende M., Ritschel M., Leonhardt A. Dispersion of carbon nanotubes and its influence on the mechanical properties of the cement matrix // *Cement and Concrete Composites*. 2012. Vol. 34. Pp. 1104–1113.
  26. Konsta-Gdoutos M. S., Metaxa Z. S., Shah S. P. Highly dispersed carbon nanotube reinforced cement based materials // *Cement and Concrete Research*. 2010. Vol. 40. Pp. 1052–1059.
  27. Konsta-Gdoutos M. S., Metaxa Z. S., Shah S. P. Multi-scale mechanical and fracture characteristics and early-age strain capacity of high performance carbon nanotube/cement nanocomposites // *Cement and Concrete Composites*. 2010. Vol. 32. Pp. 110–115.
  28. Manzur T., Yazdani N. Optimum mix ratio for carbon nanotubes in cement mortar // *KSCE Journal of Civil Engineering*. 2015. Vol. 19. № 5. Pp. 1405–1412.

Artemiy Cherkashin,  
+7(911)7737537; jizm@mail.ru

Kirill Pykhtin,  
+7(921)9890186; kirillandreevich@yahoo.co.uk

Yasmin Begich,  
+7(981)7030960; yasmin1010@yandex.ru

Polina Sherstobitova,  
+7(911)2250549; polya-sherstobitova@yandex.ru

Tatiana Koltsova,  
+7(951)6581598; annelet@yandex.ru

Артеми́й Викторович Черкашин,  
+7(911)7737537; эл. почта: jizm@mail.ru

Кирилл Андреевич Пыхтин,  
+7(921)9890186;  
эл. почта: kirillandreevich@yahoo.co.uk

Ясмин Эдинович Бегич,  
+7(981)7030960;  
эл. почта: yasmin1010@yandex.ru

Полина Андреевна Шерстобитова,  
+7(911)2250549;  
эл. почта: polya-sherstobitova@yandex.ru

Татьяна Сергеевна Кольцова,  
+7(951)6581598; эл. почта: annelet@yandex.ru

© Cherkashin A.V., Pykhtin K.A., Begich Y.E., Sherstobitova P.A., Koltsova T.S., 2017